

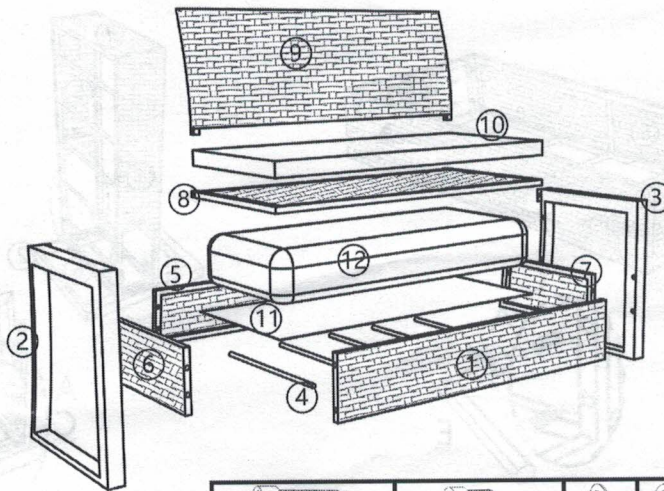

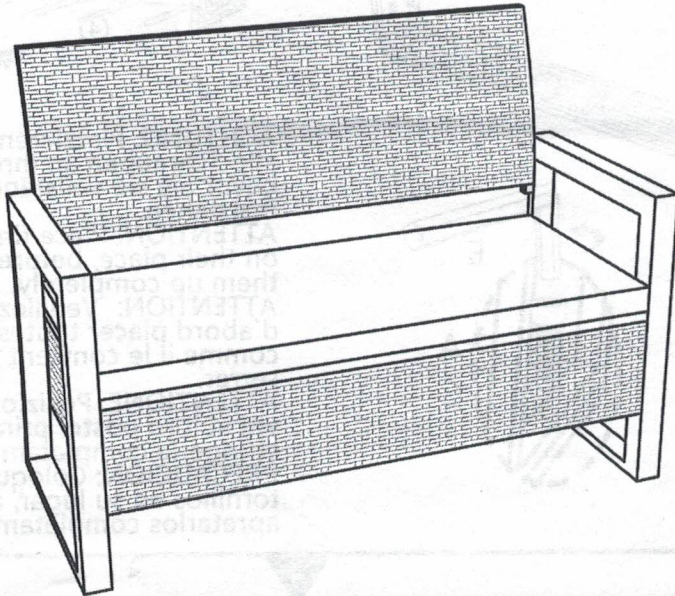



Assembly Instruction

STS-TZ13A-3S



| | | | | |
|---|---|---|--|---|
|  |  |  |  |  |
| A=M6*40mm=20 | B=M6*20mm=3 | C=23 | D=3 | E=1 |

1

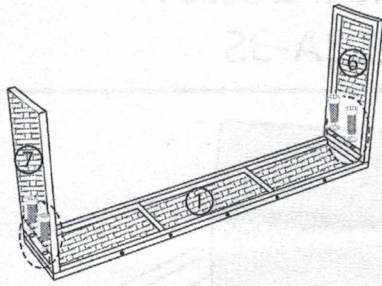

2

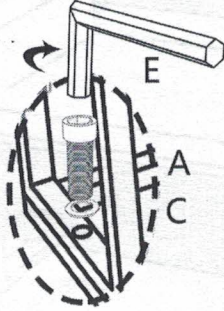
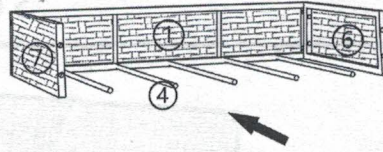

ACHTUNG: Platzieren Sie zuerst alle Schrauben an ihrem Platz, bevor Sie sie vollständig festziehen.

ATTENTION: Place first all screws on their place, before you tighten them up completely.

ATTENTION: Veuillez tout d'abord placer toutes les vis comme il le convient avant de les serrer.

ATTENZIONE: Posizionare tutte le viti al loro posto, prima di stringerle completamente.

PRECAUCIÓN: Coloque todos los tornillos en su lugar, antes de apretarlos completamente.

3

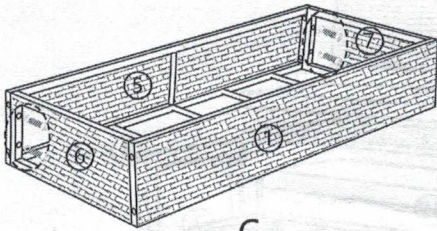

4

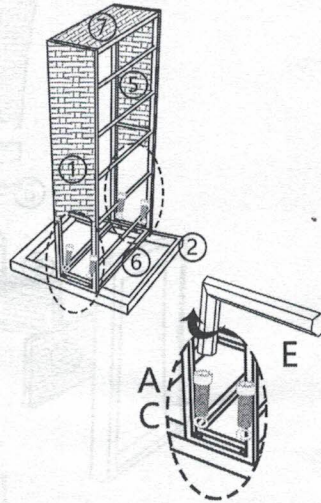
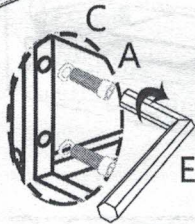

5

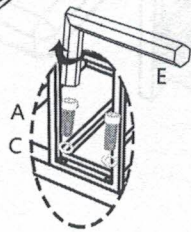
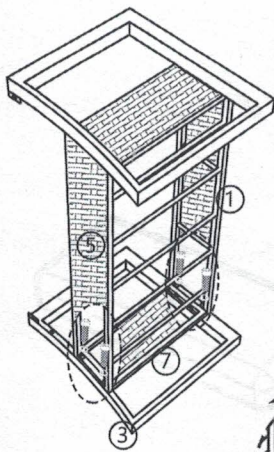

6

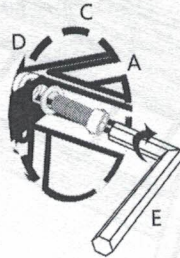
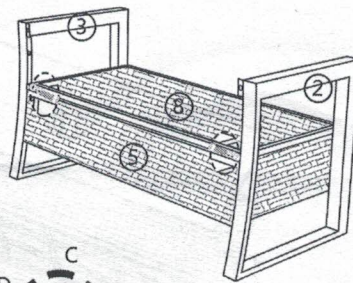

7

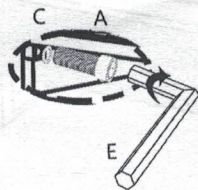
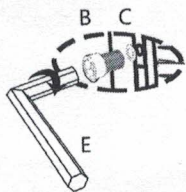
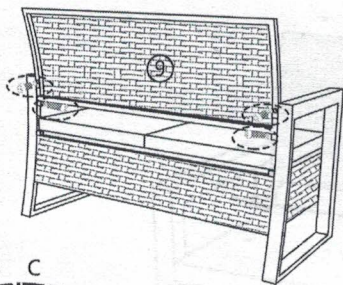

8

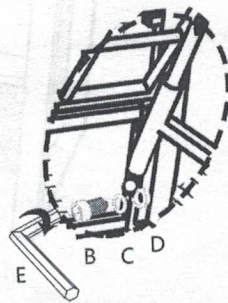
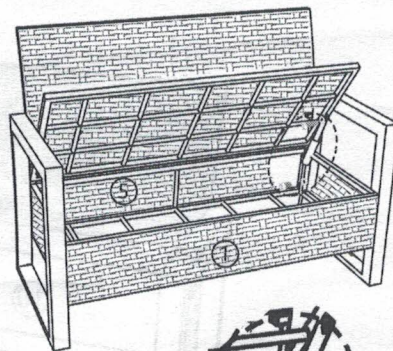

9

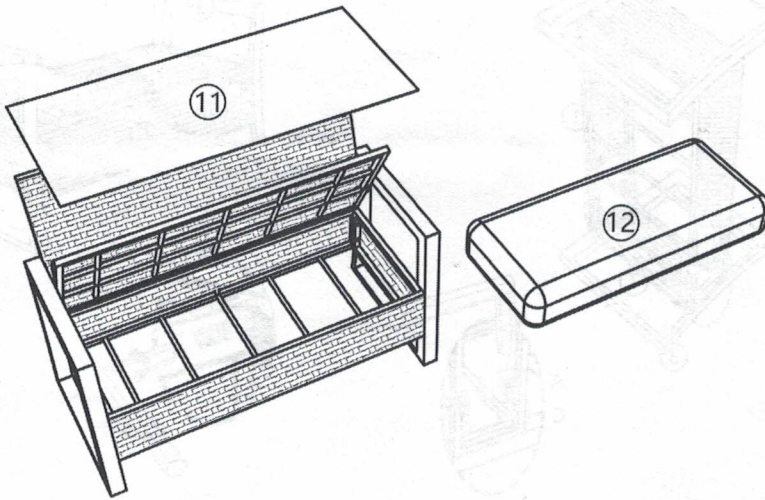

10

